

# NOMAPACK® WS

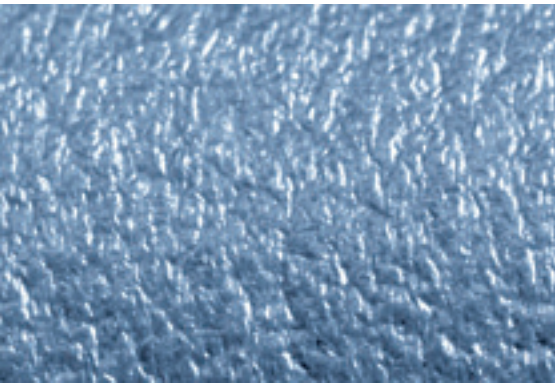

NOMAPACK® WS is an innovative transport protection for windscreens and glass. An inner reinforcement of the profile prevents piercing due to sharp edges and protects the product efficiently. An extensive assortment of tool accessories is available to simplify the handling.

- Patented glass edge protection
- Unique, with inner reinforcement
- Efficient protection against scratches and breaks

## Product features

- PE-LD foam
- CFC & HCFC free
- Density from 25 kg/m<sup>3</sup> up to 63 kg/m<sup>3</sup>
- Supplied as coils
- Water absorption < 1 - vol.% after 40 days
- 100% recyclable



NMC reserves the right to update the product line or its technical features to the state-of-the-art technology anytime and without previous announcement. All given information is to the best of our knowledge. If you have any questions concerning technical details please contact the NMC information service. Any partial reproduction or reprint shall require our explicit approval.

For further information, please contact the respective subsidiary in your country. Visit [www.nmc.eu/contact](http://www.nmc.eu/contact)

[www.nmc.eu](http://www.nmc.eu)



# NOMAPACK® WS 33x26



- Specially designed for thicknesses from 3 mm to 6 mm or for windscreens without rubber lips
- Good grip force by high lip tension
- Available with or without inner reinforcement
- Supplied as endless coil for pieces cut to your own requirements

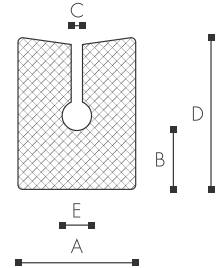

Type	A mm	B mm	C mm	D mm	E mm	Density	Length	Packaging unit	Item code
33x26 BC	26 $+1/1$	12 $+1/1$	3	33 $+1/1$	6 $+1/0$	63 kg/m <sup>3</sup> $+2/2$	460 m $\pm 2\%$	460 m/rol	KPPW33263000
33x26 CBC	26 $+1/1$	12 $+1/1$	3	33,5 $+1/1$	6 $+1/0$	45 kg/m <sup>3</sup> $+2/2$	460 m $\pm 2\%$	460 m/rol	KPPW33263007
33x26 CYC	26 $+1/1$	12 $+1/1$	3	33 $+1/1$	6 $+1/0$	63 kg/m <sup>3</sup> $+2/2$	460 m $\pm 2\%$	460 m/rol	KPPW33260006

# NOMAPACK® WS 33x26 Edge-Pad CYC



- Effective protection for glass, mirrors and sensitive metal goods
- Pre-cut with patented inner reinforcement
- Supplied as endless coil for pieces cut to your own requirements

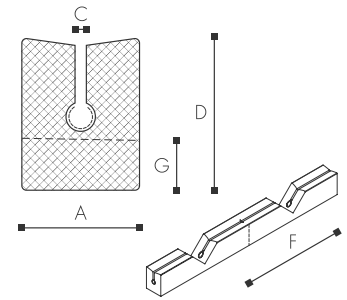

Type	A mm	G mm	C mm	D mm	F mm	Density	Length	Packaging unit	Item code
33x26 Edge-Pad CYC	26 $+1/1$	11 $+1/1$	3	33 $+1/1$	160 $+7/7$	63 kg/m <sup>3</sup> $+2/2$	460 m $\pm 2\%$	460 m/rol	KPPW33260013

# NOMAPACK® WS 33x26 Edge-Pad YC



- Safe protection for glass, mirrors and sensitive metal goods
- Available with or without perforations
- Efficiently protects fragile goods during transport
- Supplied as endless coil for pieces cut to your own requirements

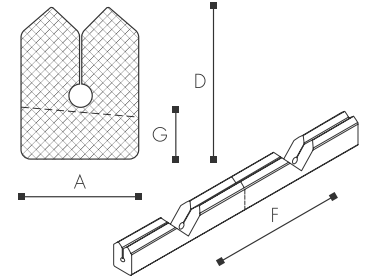

Type	A	G	C	D	F	Density	Length	Packaging unit	Item code
	mm	mm	mm	mm	mm				
33x26 Edge-Pad YC	25 $+1/-1$	11 $+1/-1$	+	33 $+1/-1$	160 $+7/-7$	55 kg/m <sup>3</sup> $+2/-2$	460 m $\pm 2\%$	460 m/rol	KPPW33260001

# NOMAPACK® WS 35x26



- „Universal“ transport protection for windscreens with or without rubber lips
- Specially developed inner-shape that adapts itself to all types of windscreens
- Supplied as endless coil for pieces cut to your own requirements

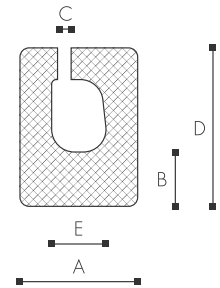

Type	A	B	C	D	E	Density	Length	Packaging unit	Item code
	mm	mm	mm	mm	mm				
35x26 BC	26 $+1/-1$	12 $+1/-1$	3	35 $+2/-2$	12 $+1/0$	50 kg/m <sup>3</sup> $+2/-2$	350 m $\pm 2\%$	350 m/rol	KPPW35263000
35x26 CBC	26 $+1/-1$	12 $+1/-1$	3	35 $+2/-2$	12 $+1/0$	50 kg/m <sup>3</sup> $+2/-2$	350 m $\pm 2\%$	350 m/rol	KPPW35263001

## NOMAPACK® WS 40x30



- Ideal for windscreens with an inside rubber lip
- Supplied as endless coil for pieces cut to your own requirements

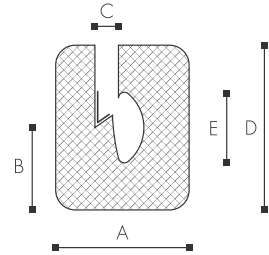

Type	A mm	B mm	C mm	D mm	E mm	Density	Length	Packaging unit	Item code
40x30 CBC	34 $+2/-2$	21 $+1/-1$	6	42 $+2/-2$	18 $+1/-1$	55 kg/m <sup>3</sup> $+2/-2$	270 m $\pm 2\%$	270 m/rol	KPPW40303001

## NOMAPACK® WS 45x26



- For windscreens with or without rubber lips
- Adapts itself perfectly to most windscreens
- Supplied as endless coil for pieces cut to your own requirements

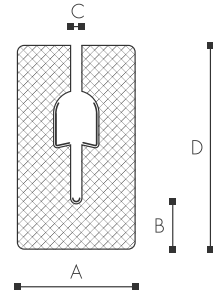

Type	A mm	B mm	C mm	D mm	Density	Length	Packaging unit	Item code
45x26 CBC	26 $+1/-1$	10 $+1/-1$	3	45 $+2/-2$	55 kg/m <sup>3</sup> $+2/-2$	270 m $\pm 2\%$	270 m/rol	KPPW45263000

# NOMAPACK® WS 60x30



- Ideal for windscreens with a seal in the outside part of the glass pane
- Supplied as endless coil for pieces cut to your own requirements

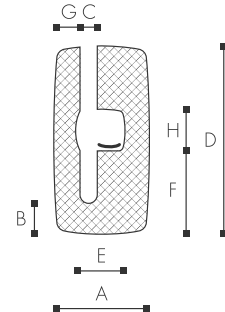

Type	A	B	C	D	E	F	G	H	Density	Length	Packaging unit	Item code
	mm	mm	mm	mm	mm	mm	mm	mm				
60x30 CBC	31 $\pm 2/2$	10 $\pm 1/1$	$\pm 5,5$	61 $\pm 3/3$	16 $\pm 1/1$	27 $\pm 2/2$	8,5 $\pm 1/1$	13,5 $\pm 1/1$	45 kg/m <sup>3</sup> $\pm 2/2$	200 m $\pm 2\%$	200 m/rol	KPPW60303000

## Complementary Products

### NOMAPACK® U

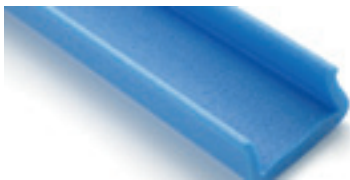

NOMAPACK® U are effective edge protection profiles for each type of corner or curve. They are available in different dimensions and densities in order to protect your products efficiently. We can also develop profiles according to customers specifications.

### NOMAPACK® L



NOMAPACK® L - profiles are available with or without adhesive. They are the ideal protection for corners, edges and scratch-sensitive flat products. They supply protection for individual pieces or can work as protection of a whole pallet.

### NOMAPACK® C



The NOMAPACK® C range has been specially designed to protect both ceramics and offers customized solutions for many different applications.

